

ITS

TEST REPORT

ELECTROPLATING TEST REPORT

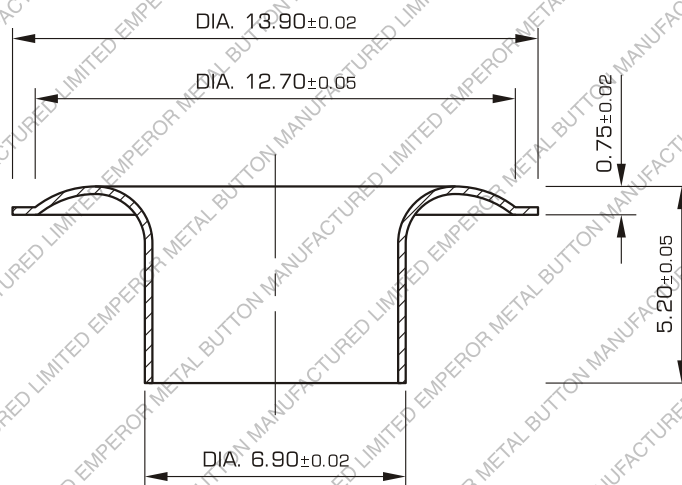
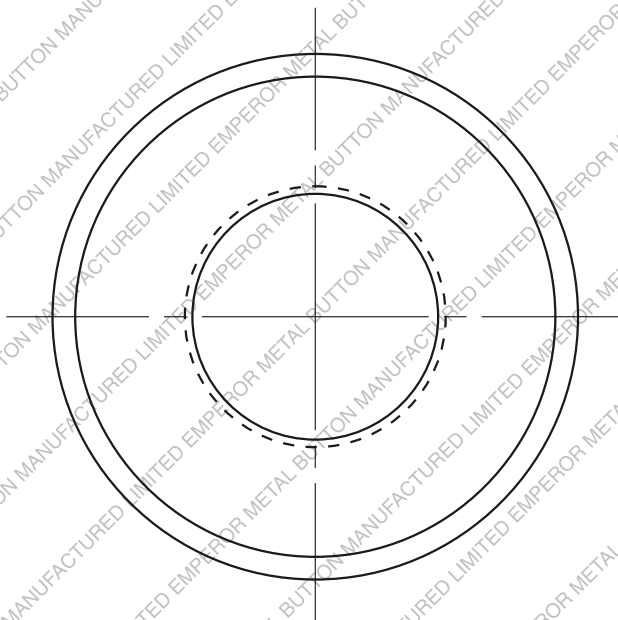

TITLE

14# EYELET



MATERIAL  
0.20  
BRASS

HARDNESS

SCALE  
5 : 1

SHEET NO.  
1 OF 1

EMPEROR

METAL BUTTON MFY. LTD.

UNLESS OTHERWISE SPECIFIED

DIM .00 MM± .2

DIM .00 MM± .02

ANGLE±