

ITS

TEST REPORT

ELECTROPLATING TEST REPORT

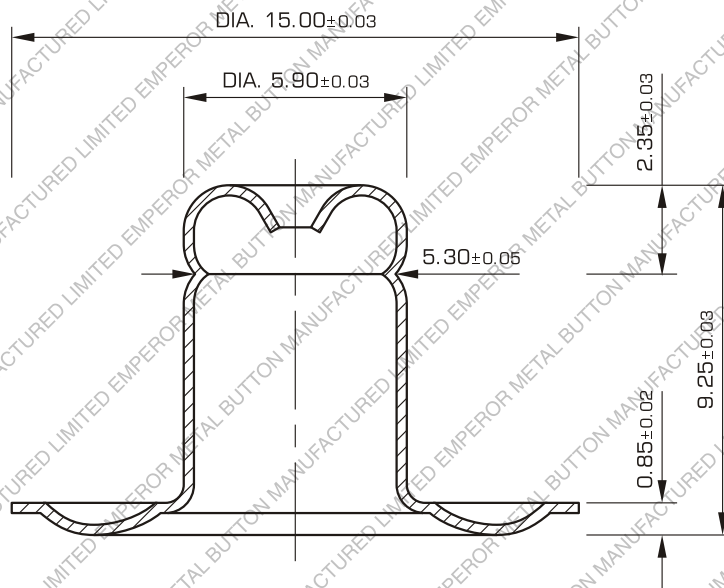
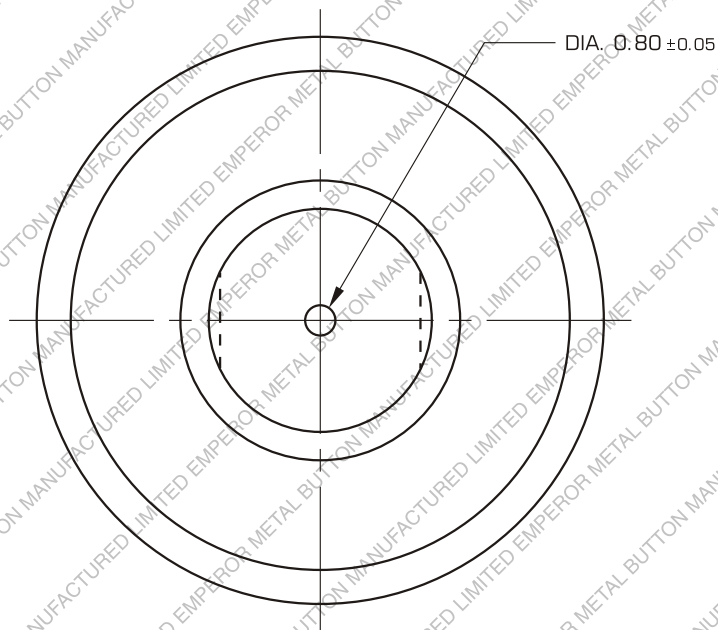

TITLE

407 D PART



MATERIAL
0.27
BRASS

HARDNESS

SCALE
5 : 1

SHEET NO.
1 OF 1

EMPEROR

METAL BUTTON MFY. LTD.

UNLESS OTHERWISE SPECIFIED

DIM	MM±	DIM	MM±	ANGLE±
.00	.2	.00	.02	