

ITS

TEST REPORT

ELECTROPLATING TEST REPORT

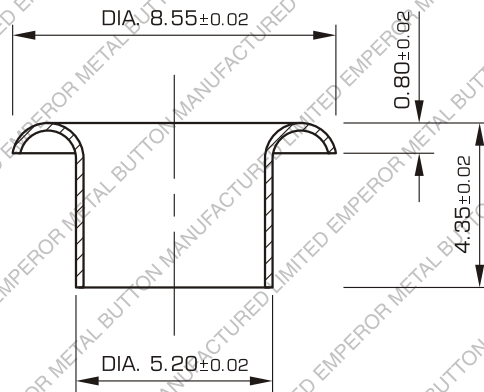
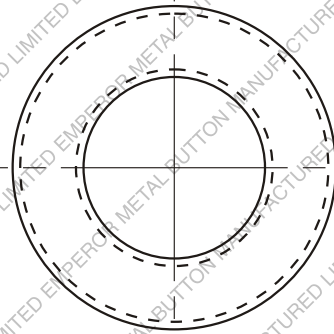

TITLE

3# EYELET



MATERIAL
0.20
BRASS

HARDNESS

SCALE
5 : 1

SHEET NO.
1 OF 1

EMPEROR

METAL BUTTON MFY. LTD.

UNLESS OTHERWISE SPECIFIED

DIM .00 MM± .2

DIM .00 MM± .02

ANGLE±