

ITS

TEST REPORT

ELECTROPLATING TEST REPORT

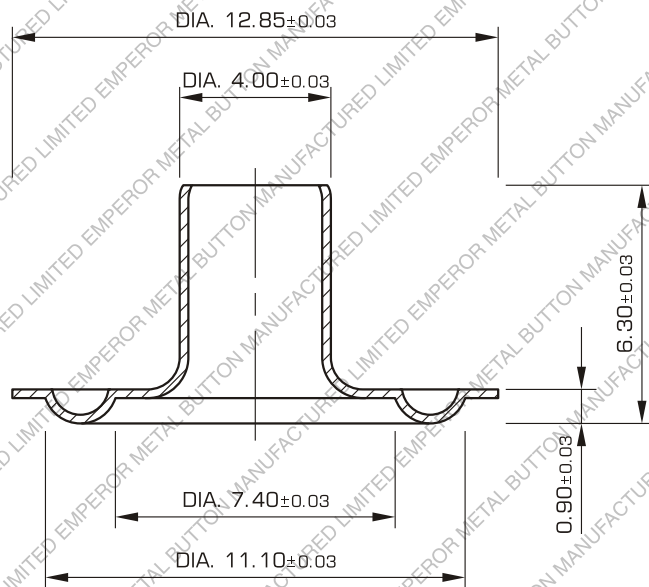
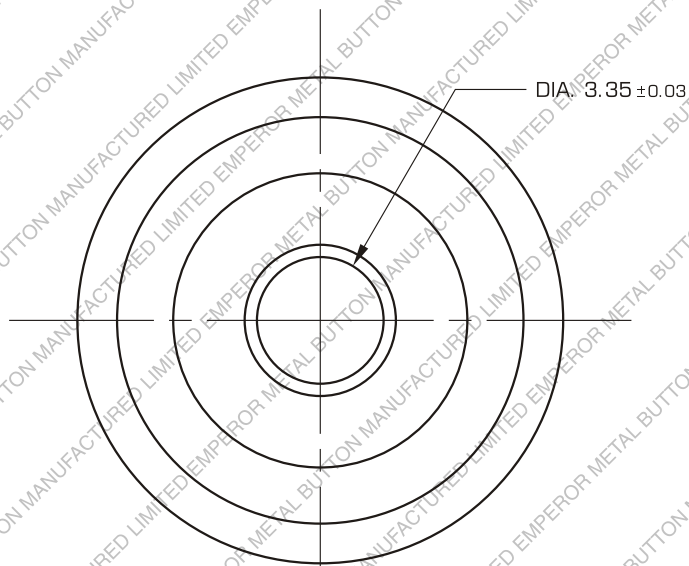

TITLE

405 D PART



MATERIAL
0.23
BRASS

HARDNESS

SCALE
5 : 1

SHEET NO.
1 OF 1

EMPEROR

METAL BUTTON MFY. LTD.

UNLESS OTHERWISE SPECIFIED

DIM MM±
.00 .2

DIM MM±
.00 .02

ANGLE±