

ITS

TEST REPORT

ELECTROPLATING TEST REPORT

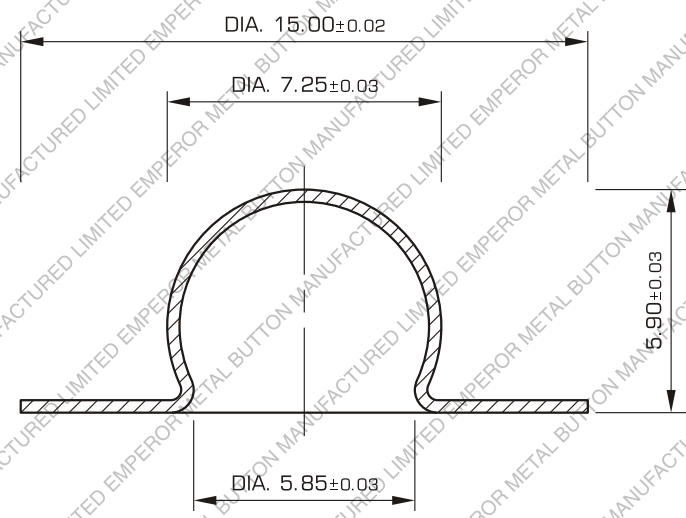
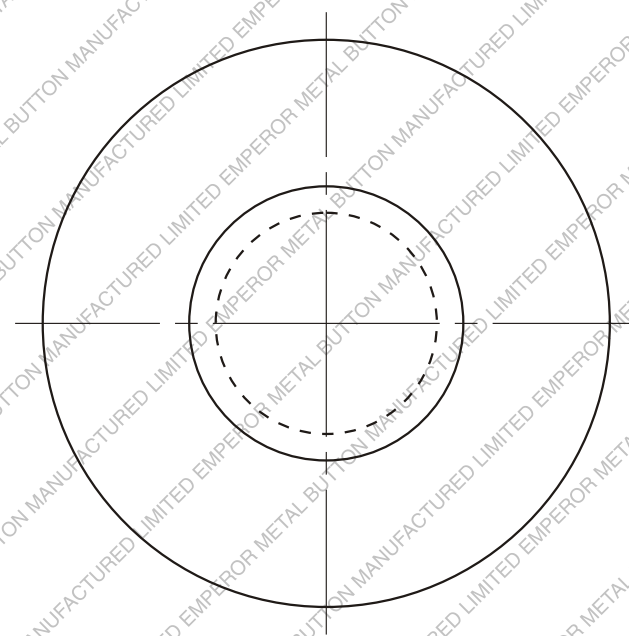

TITLE

407 C PART



MATERIAL
**0.33
BRASS**

HARDNESS

SCALE
5 : 1

SHEET NO.
1 OF 1

EMPEROR

METAL BUTTON MFY. LTD.

UNLESS OTHERWISE SPECIFIED

DIM	MM±	DIM	MM±	ANGLE±
.00	.2	.00	.02	